

恆日”玄武系列” Lighten®Dragon Tortoise® Series –LTHX1002-010-005



產品簡介 PRODUCT DESCRIPTION

恆日”玄武系列”為一結合高導熱(銅基板)、高信賴性、寬可視角、COB 多晶封裝、易組裝、無暗區專為球泡燈、崁燈等面光源燈具所設計之高效能模組。

Lighten Dragon Tortoise Series is a high performance LED module and design with high Thermal conductivity、high reliability、wide view angle、multichip COB package、easy to assembly、Non dark area for Bulb、Down light... etc for surface light application.

特徵 FEATURES

- 電壓 Forward Voltage:31V
- 電流 Drive Current:300mA
- 最大電流 Max. Drive Current:330mA
- 可視角 View Angle:120°
- 芯片直接與銅基板鍵結 Die Direct bonding to copper
- 高導熱 High thermal conductivity: 401W/(m·K)
- 溫度量測點 Thermocouple attach point
- 通過六項重金屬檢驗 ROHS compliant
- 容易組裝 Easy for Fixture assembly:最少只鎖兩顆螺絲 Only need to lock two screw

特性 CHARACTERISTIC

特性 Characteristics	最小值 Minimum	額定值 Typical	最大值 Maximum	單位 Unit
輸入電流 DC Forward Current		300	330	mA
逆電流 Reverse Current			0.1	mA
輸入電壓 Forward Voltage	27.9	31	34.1	V
結溫 LED Junction Temperature			120	°C

光通量特性及標準編碼原則
FLUX CHARACTERISTICS, STANDARD CODES AND BINS

Group	最低亮度 Min. flux(lm/W)	最高亮度 Max. flux(lm/W)
N1	55	62
N2	62	70
O1	70	77
O2	77	85
P1	85	92
P2	92	100
Q1	100	107
Q2	107	115
R1	115	122
R2	122	130
S1	130	137
S2	137	145
T1	145	152
T2	152	160
U1	160	167
U2	167	175
X1	175	182
X2	182	190

注意事項

- 恆日維持光通量之量測誤差為±7%,色彩飽和度量測誤差為±2.
Lighten maintains a tolerance of ±7% on flux and power measurements and a tolerance of ±2 on CRI measurements.
- 以上色溫及演色性為恆日標準規格,可依客戶需求調整
- Above CCT and CRI spec for Lighten Standard product, different CCT and CRI are available upon customer's

波長特性(額定電流, Ta=25°C) WAVELENGTH CHARACTERISTICS AT RATED TEST CURRENT, Ta=25°C

Typical Cool White Color Spectrum

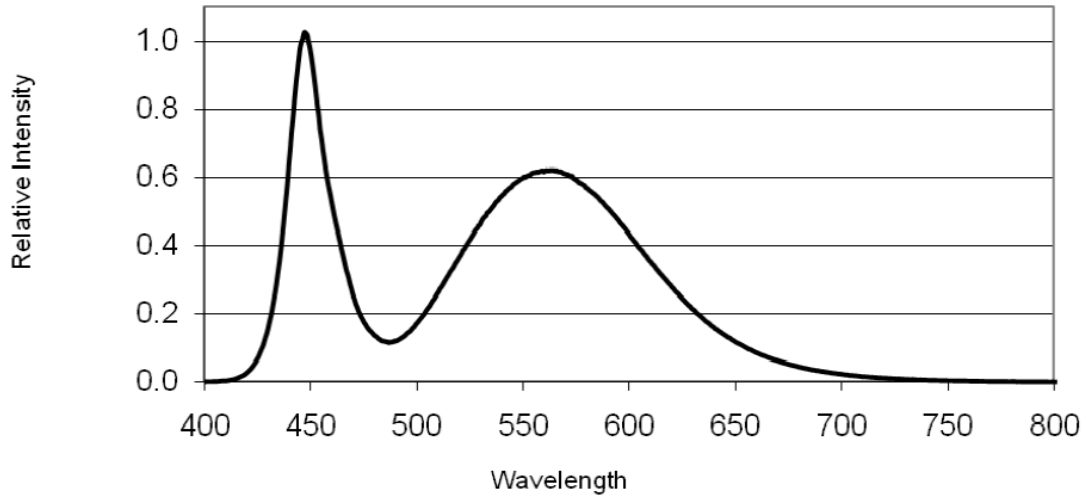

Typical Neutral White Color Spectrum

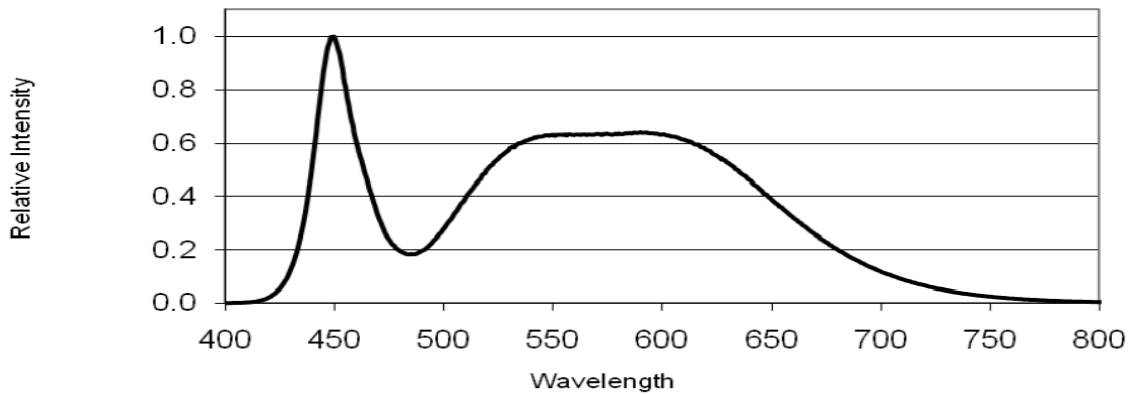

Typical Warm White Color Spectrum

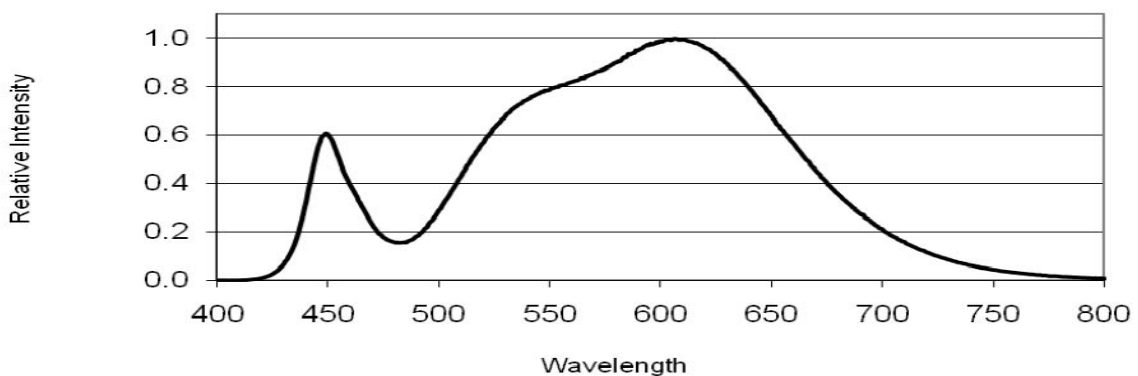

空間分布 TYPICAL SPATIAL DISTRIBUTION

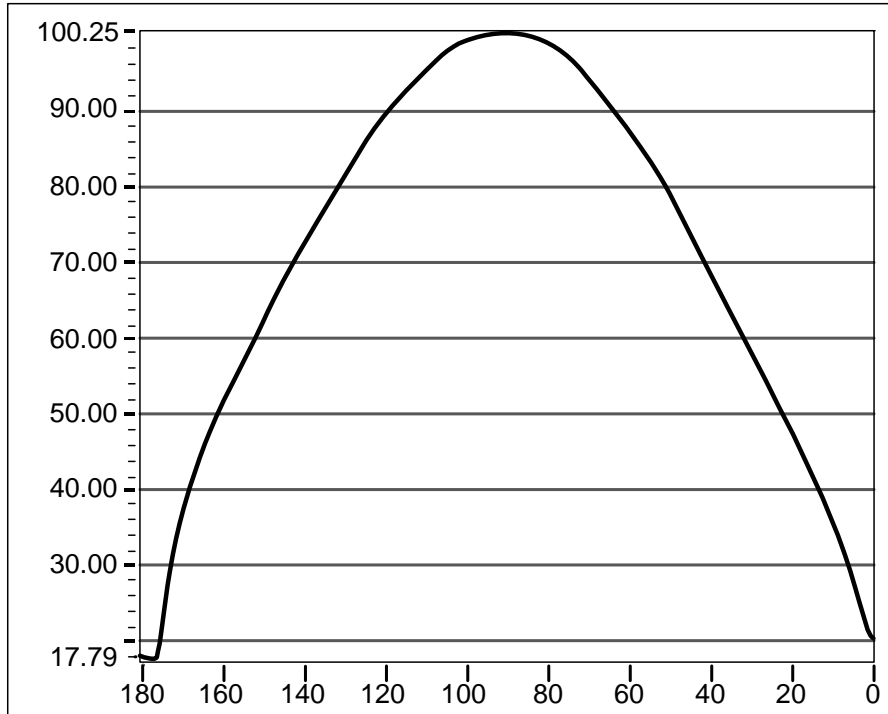

光形圖 TYPICAL POLAR RADIATION PATTERN

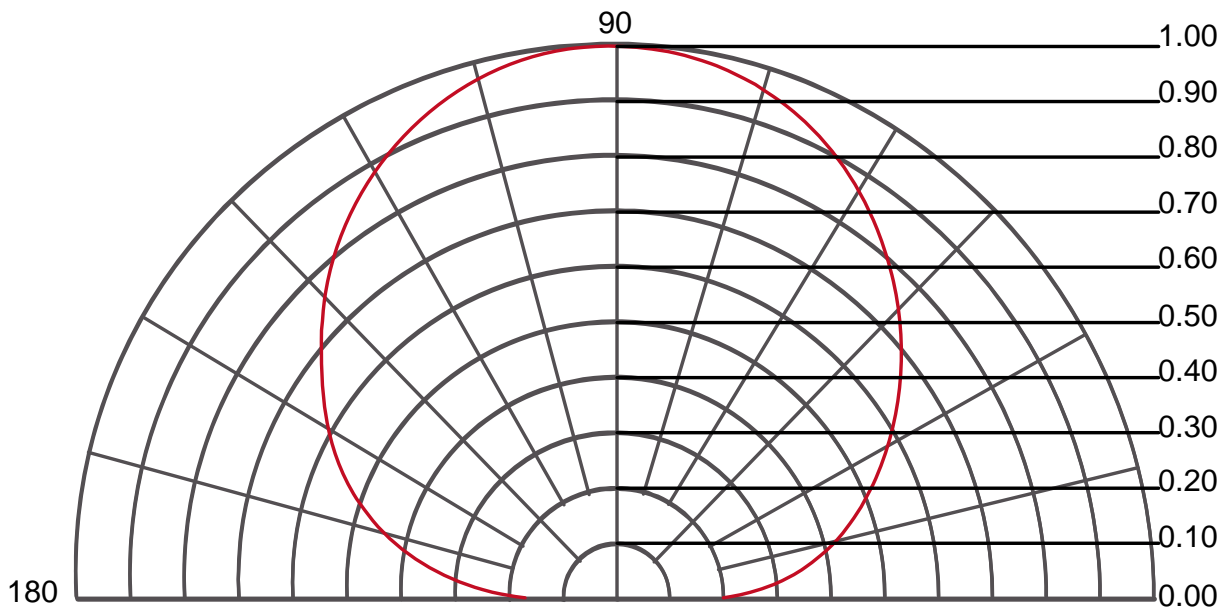



色溫 BIN 區範圍

CCT 2700K

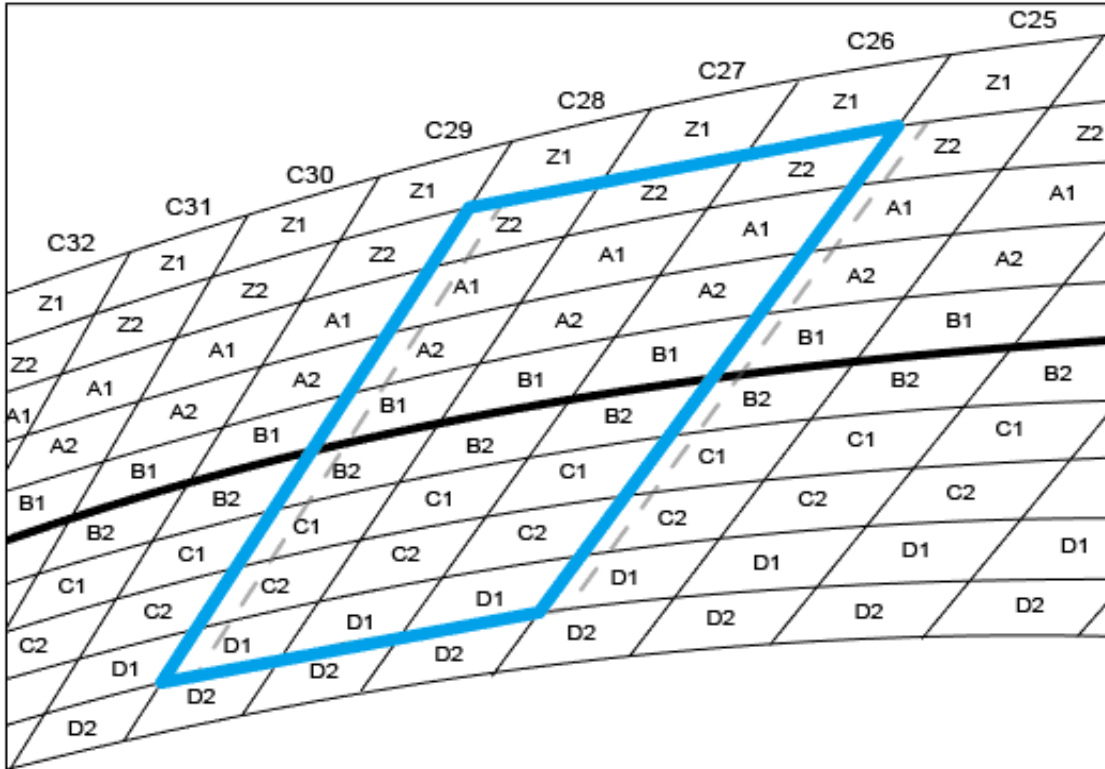

CCT 3000K

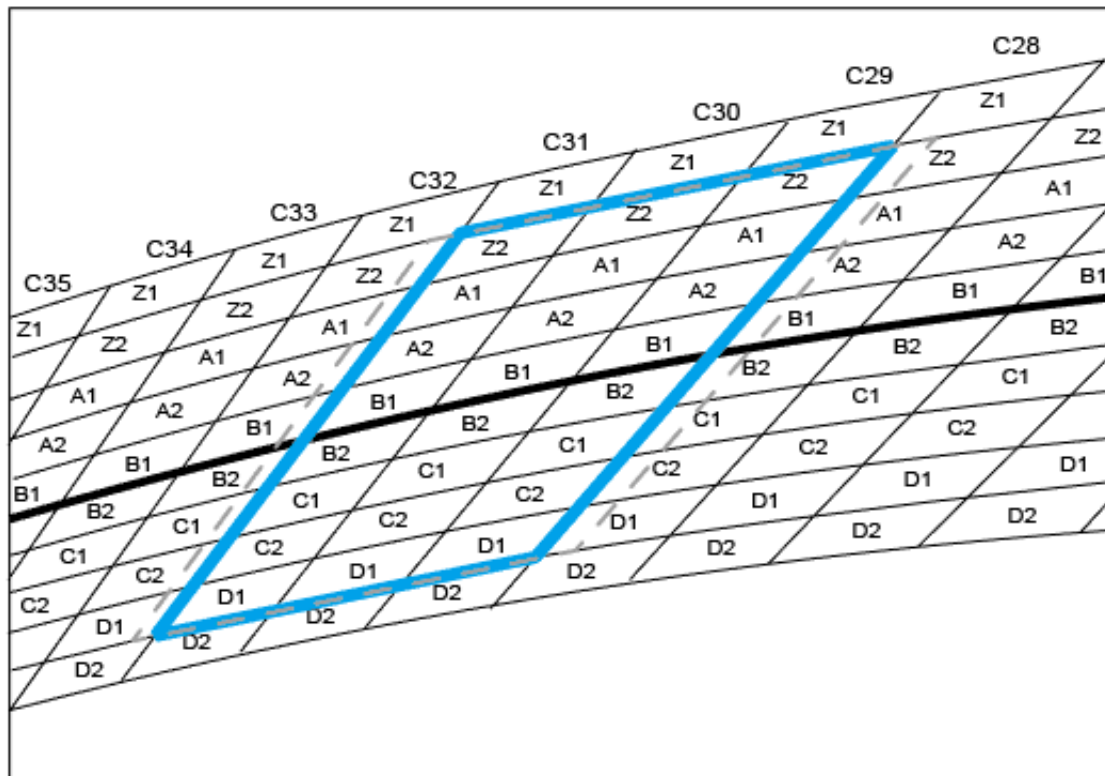

色溫 BIN 區範圍

CCT 3500K

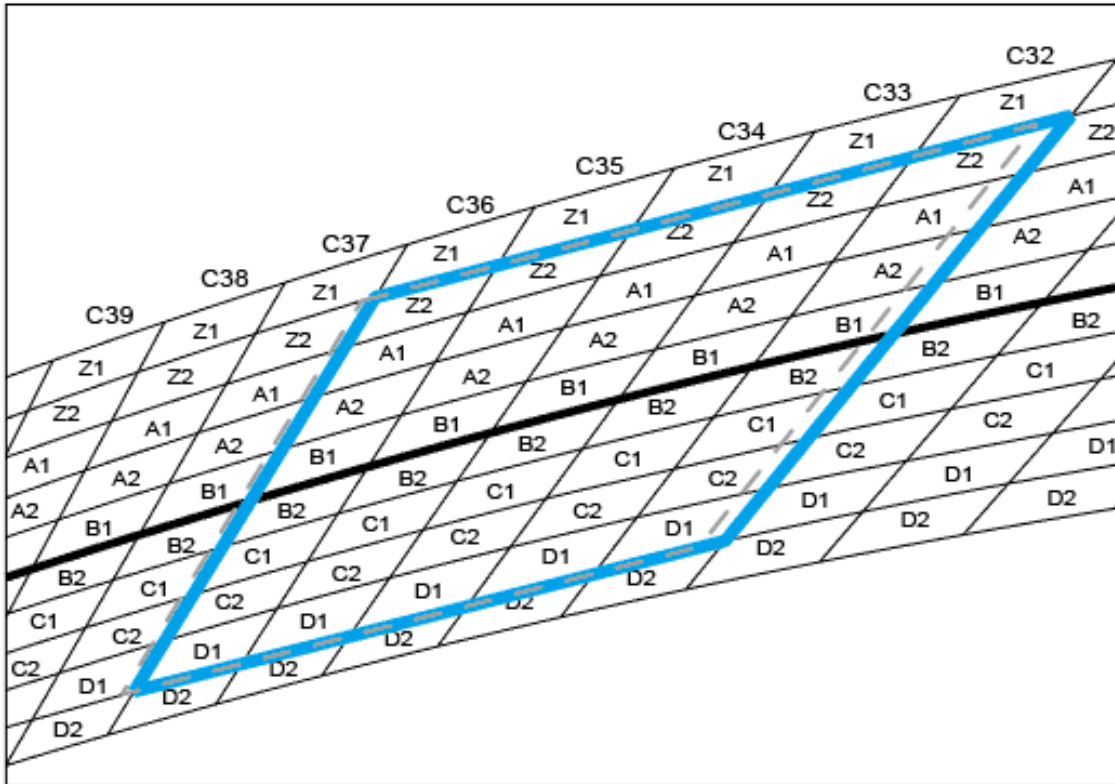

CCT 4000K

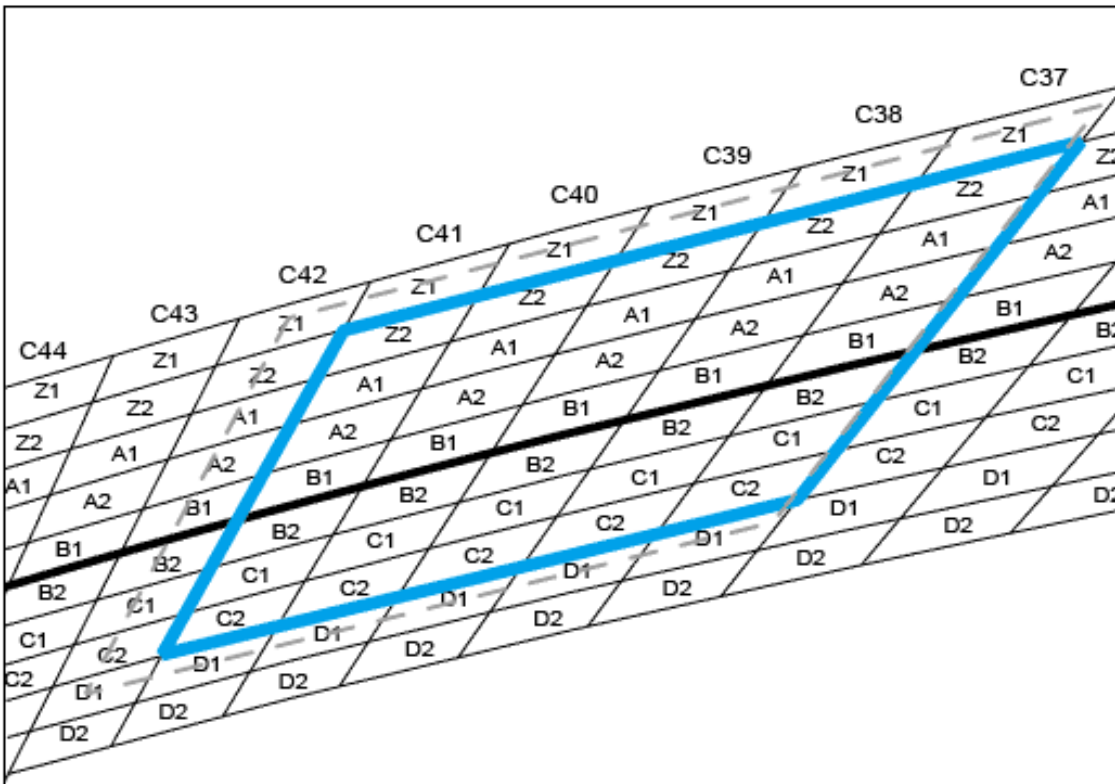

色溫 BIN 區範圍

CCT 4500K

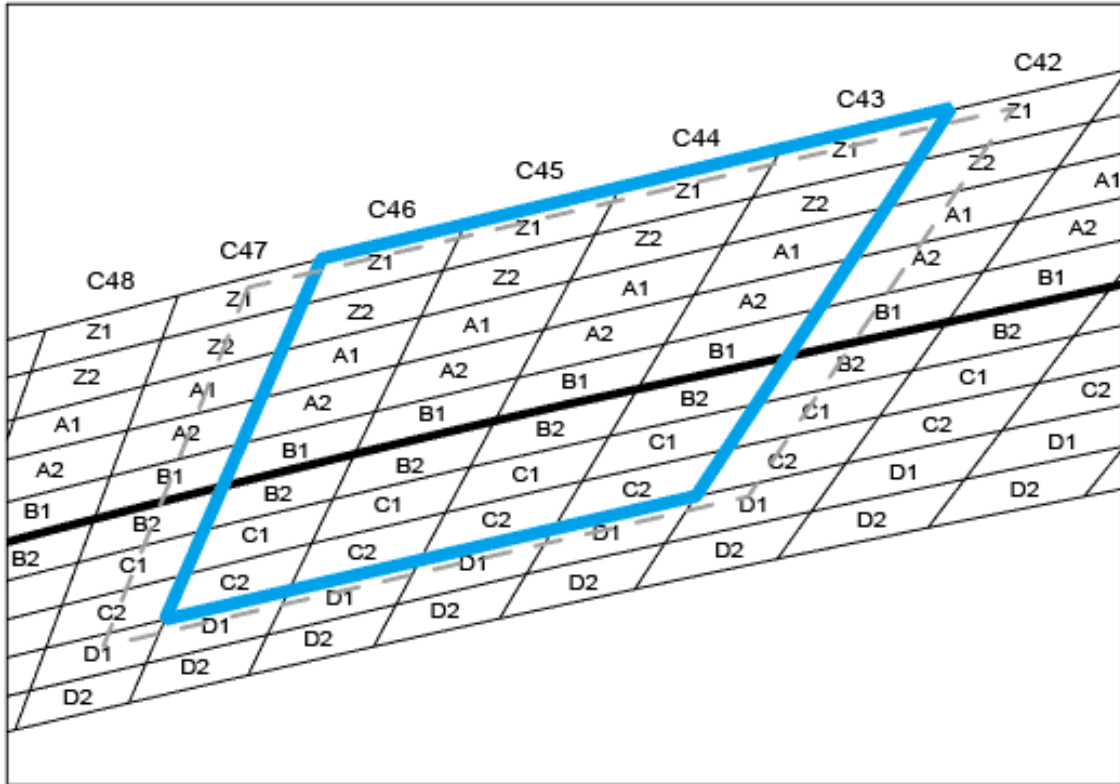

CCT 5000K

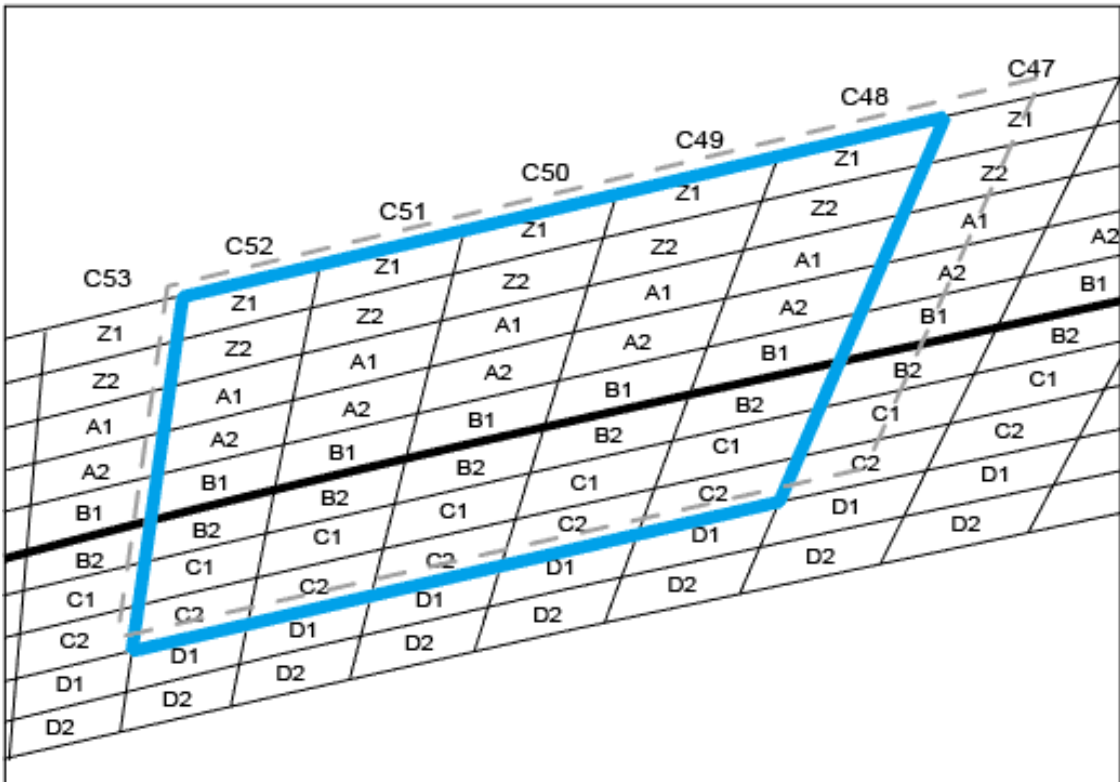

色溫 BIN 區範圍

CCT 5700K

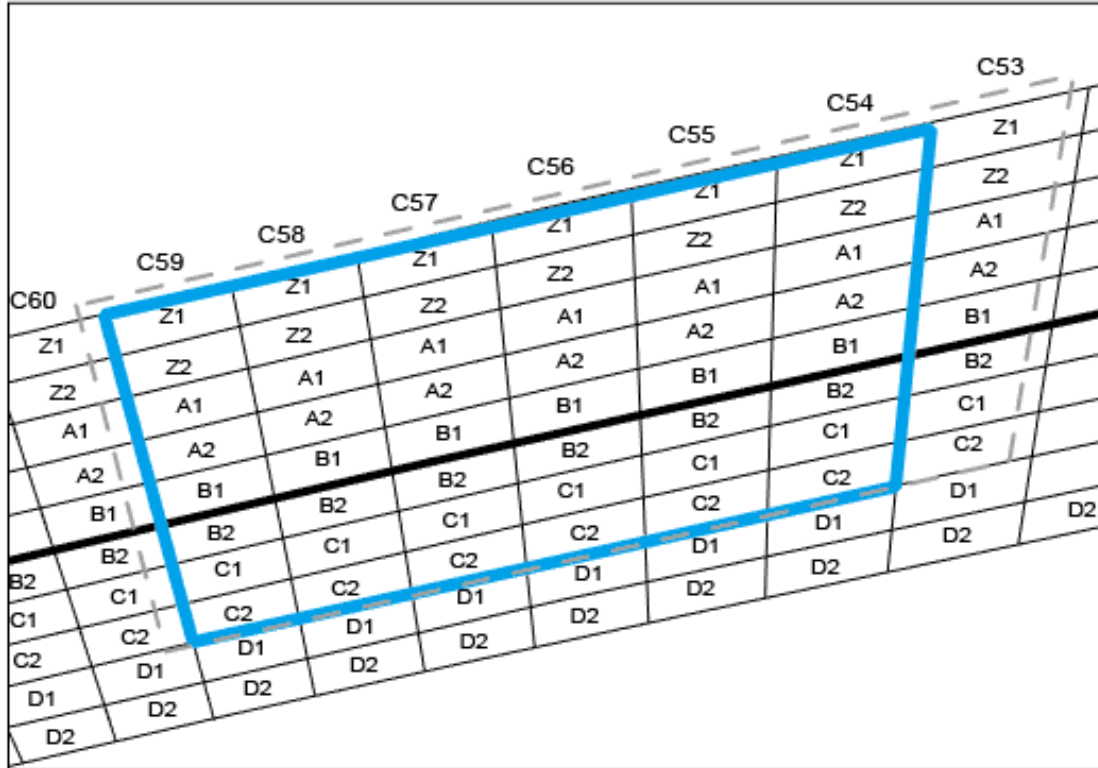

A 10x10 grid diagram for CCT 5700K. The grid is tilted. A blue trapezoidal boundary highlights a specific region. The grid is labeled with columns C53 to C60 and rows Z1 to D2. The highlighted region includes columns C54 to C59 and rows Z1 to D2.

CCT 6500K

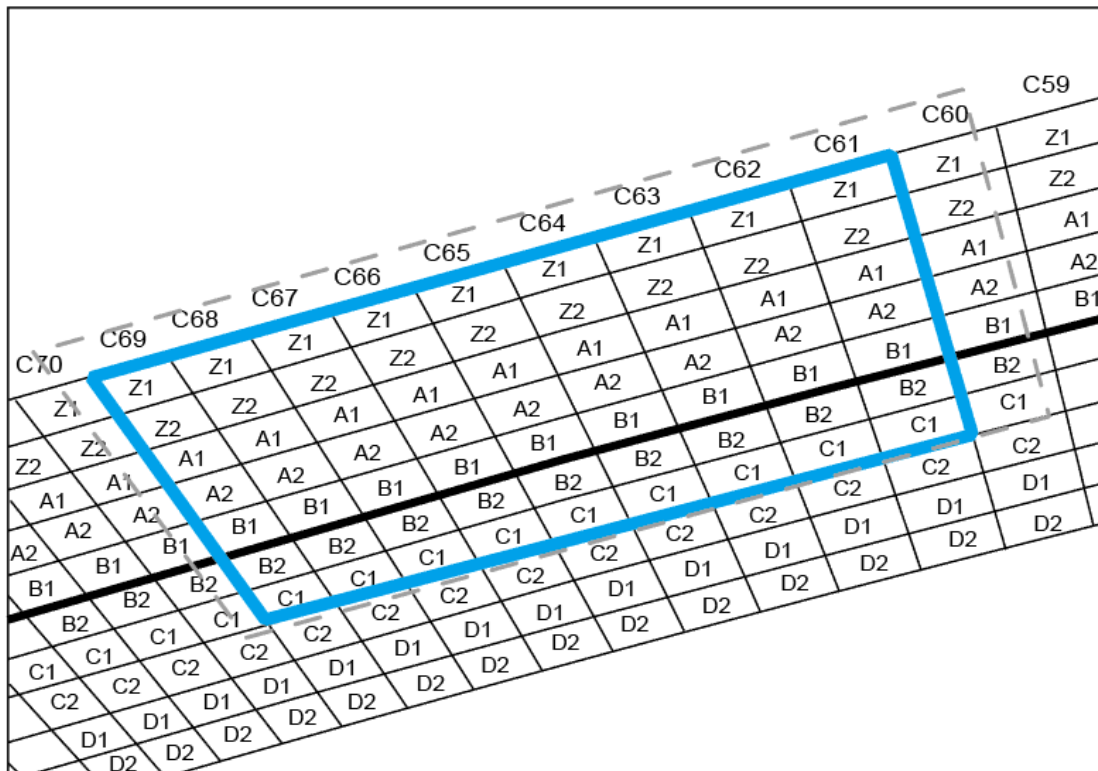

A 10x10 grid diagram for CCT 6500K. The grid is tilted. A blue trapezoidal boundary highlights a specific region. The grid is labeled with columns C59 to C70 and rows Z1 to D2. The highlighted region includes columns C60 to C65 and rows Z1 to D2.

不同電流下之 相對光通量百分比 **Relative Luminous Flux vs Current (Ta=25°C)**

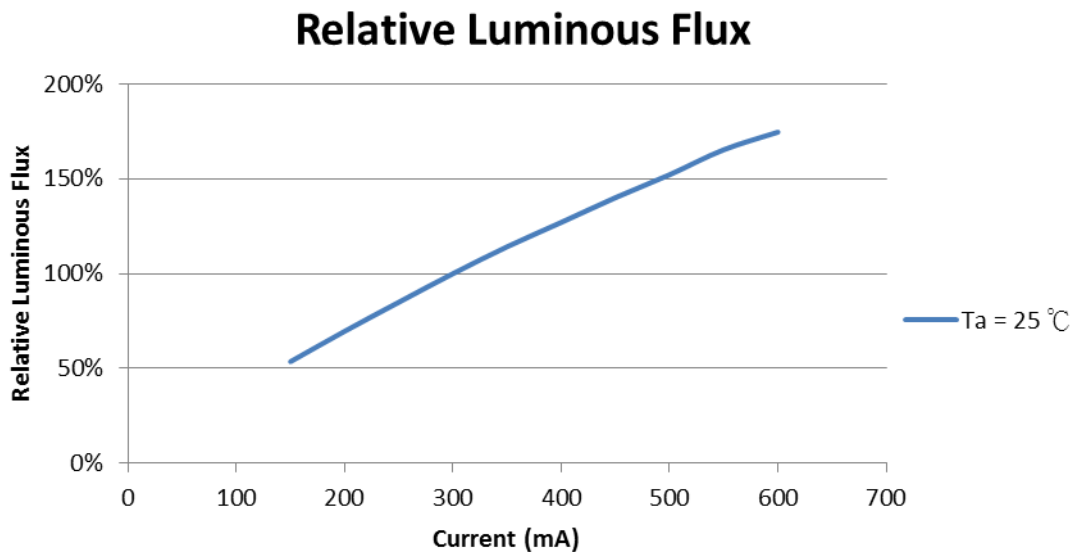

不同電流下之電壓值 **I-V Curve (Ta=25°C)**

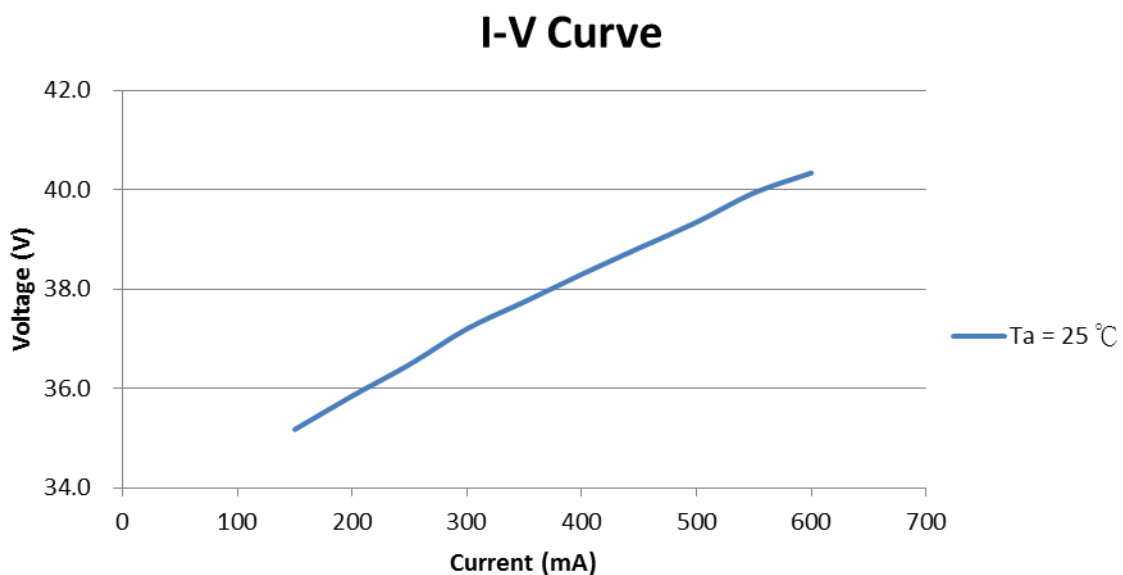

注意事項 Notice:

1. 當操作電流為標準電流時, Tp 點須控制在 75°C 下 Tp should be controlled below 75°C under typical current .
2. 當操作電流為最大電流時, Tp 點須控制在 65°C 下 Tp should be controlled below 65°C under maximum current .

訂單碼格式 ORDER CODES FORMAT

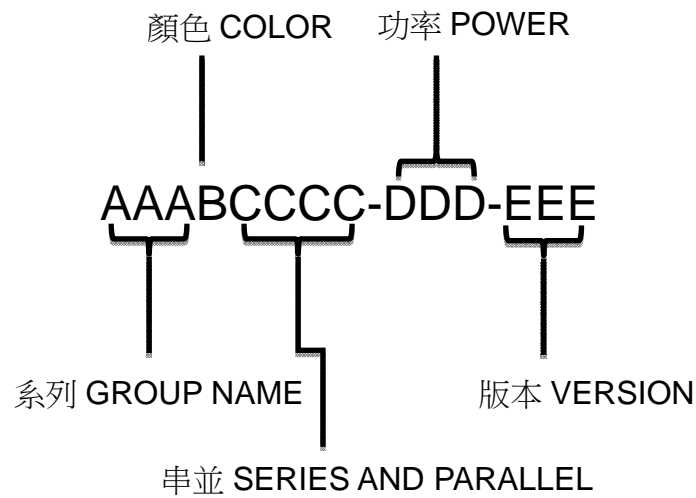

注意事項 NOTES

外觀尺寸(單位：公釐) EMITTER OUTLINE DIMENSION(UNIT:mm)

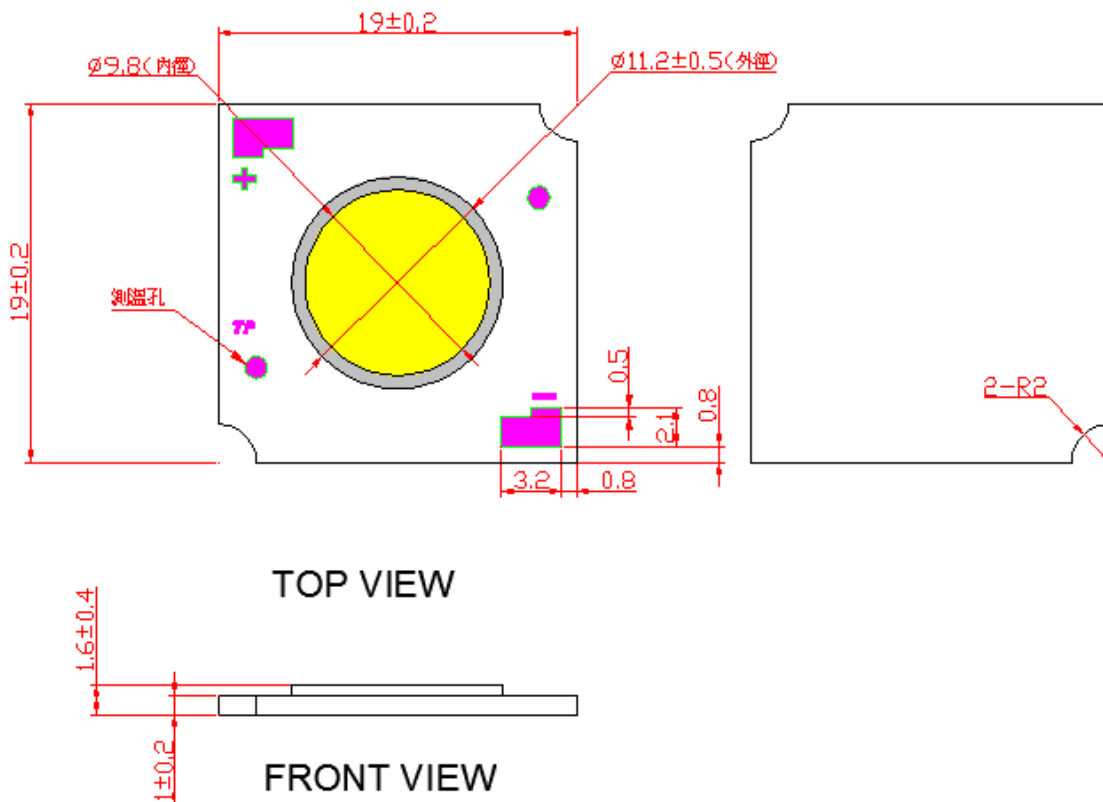

包裝方式 PACKING SPEC.

包裝盤尺寸 PET TRAY dimension

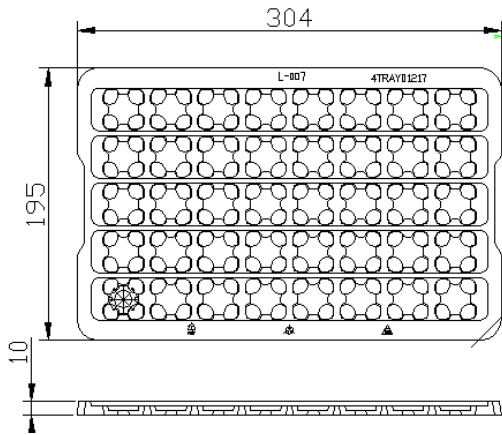

外標籤格式 Label format



燈芯擺入包裝盤 Put Emitter onto tray
 最上層貼標籤不同 Bin 或 Lot 亦需貼標
 Tape label on top cover (also applied
 on different Bin or Lot)

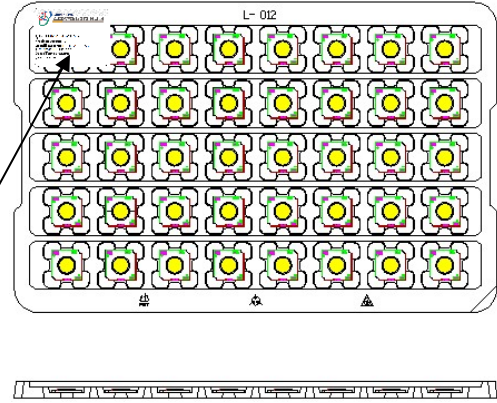

堆疊至滿箱並加 1 片上蓋
 Stack up with 1 cover (full)



裝入緩衝材 Put tray into Buffering sheet

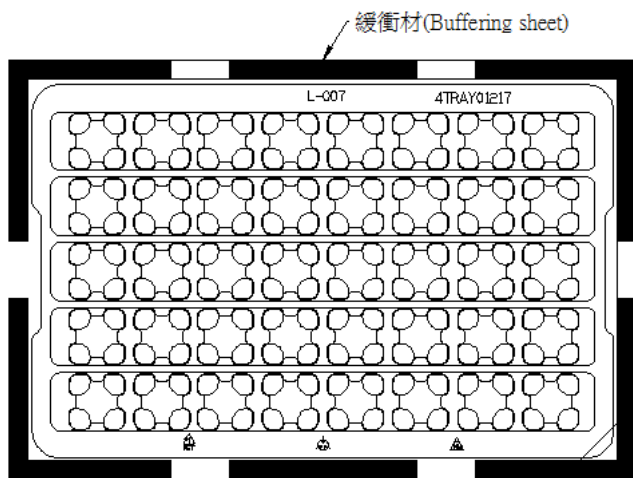

蓋上緩衝材上蓋 Add buffering sheet cover



裝入小箱並貼標
Put into Carton and add label outside

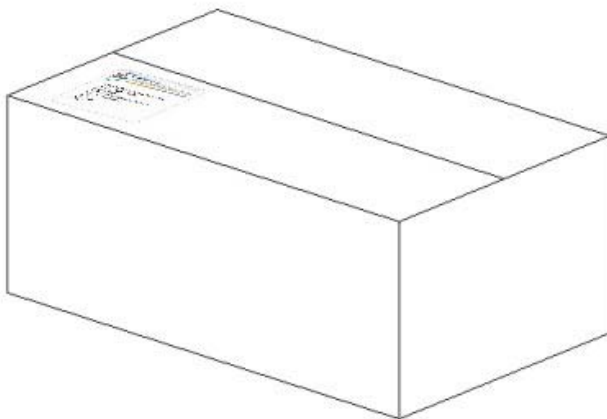

裝入外箱(外箱=4 小箱)
Put into Outer Box (4 cartons)

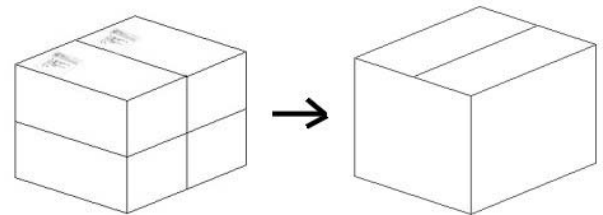

使用方式及注意事項 ASSEMBLY NOTE

禁止碰觸發光區域
 Do not touch emitting area

禁止碰觸或破壞發矽膠外型區域 會造成晶片或者是金線鍵結力，進而造成損壞現象
 Do not touch or scratch silicon forming matrix area since it could damage the bonding of LED chips or wires and cause dead zone

建議 Recommended

燈芯需要手動挑選及放置的產品,建議拿取時帶塑膠手套或使用塑膠鑷子拿取

Emitter needs manually pick and place , recommend to use plastic tweezers or plastic gloves

Don't Touch

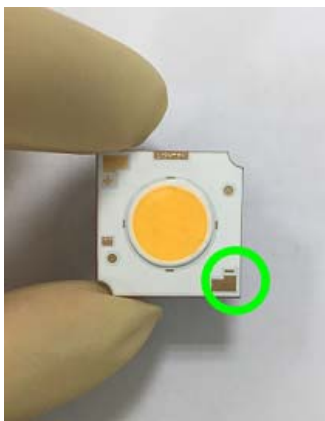
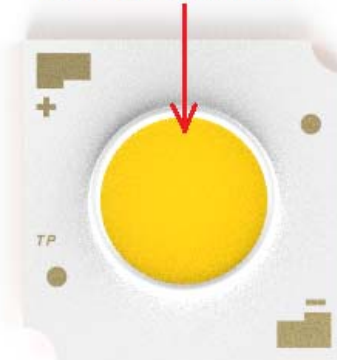

帶塑膠手套拿取
 Use plastic gloves

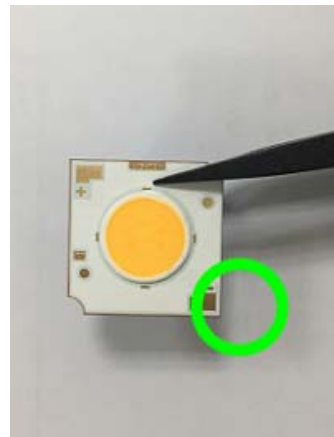

使用塑膠鑷子拿取
 Use plastic tweezers

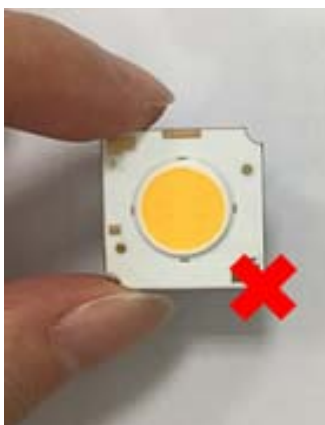

不可徒手拿取
 Don't use hand without plastic gloves



不可夾電極處
 Don't clip both electrode

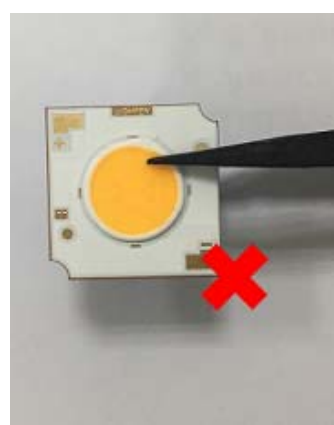

不可夾到發光區
 Don't clip emitting area



不可使用鐵製鑷子
 Don't use iron tweezers

組裝方式

Assembly guide line

先將電線焊上燈芯正面之正負極,再於孔位鎖附螺絲於鋁擠上

Wiring emitter's anode/cathode pad, then fix emitter with screws onto heat sink



為減低熱阻與散熱器保持絕緣，建議燈芯與散熱器中間介面加上高導熱絕緣材質，散熱膏或貼片皆可
To reduce thermal resistance and keep insulation of heatsink , high thermal insulating material is recommended to be used uniformly between emitter and heatsink . Either thermal sheet or paste are fine.

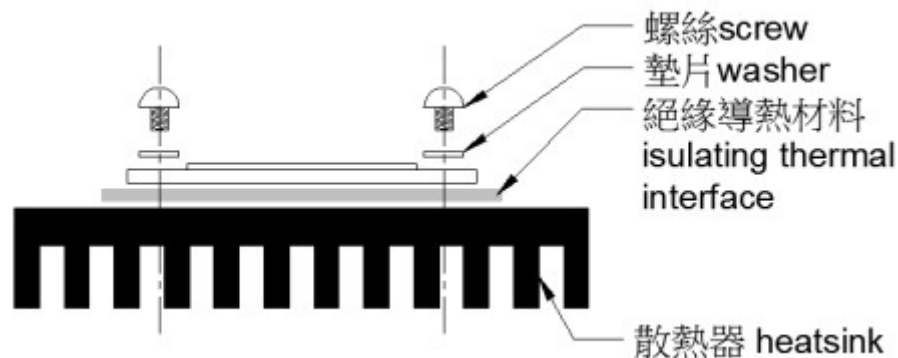

焊接條件 Soldering method

- ★ 設定焊頭溫度 $400\pm 10^{\circ}\text{C}$
Setup the temperature of welding head to $400\pm 10^{\circ}\text{C}$ when soldering
- ★ 將燈芯放在 $100\pm 10^{\circ}\text{C}$ 熱盤上，將焊槍溫度設為 $300\pm 10^{\circ}\text{C}$
Put emitter on a $100\pm 10^{\circ}\text{C}$ hot plate and setup welding head temperature to $300\pm 10^{\circ}\text{C}$
以上兩者皆可(either is ok)

電線:

- ★ 燈芯外接電源建議使用絞線（及軟性電線），勿使用單芯線（較硬）
Suggested using strand wires (softer) to connect power , don't use solid wires .